



*This product is sold
and supported
in the USA by*



LASER LAB SOURCE
marketplace for **Scientists & Engineers**

Laser Diode Part Number: 1470LD-2-0-0

contact@laserlabsource.com | 800-887-5065

1470 nm laser diode - DFB

Model 2 : >40 mW / singlemode fiber / 14 pin Butterfly package

Reference: 1470LD-2-0-0-1 or 2 (SMF of PMF)

Technology : DFB*

SPECIFICATIONS	Unit	Min	Typ	Maximum
Output Power (CW mode)	mW	40		
Output Power (Pulse mode)	mW		60	
Center Wavelength (CW)	nm	1465	1470	1475
Spectral Width (FWHM)	kHz		160	200
Threshold Current	mA		8	20
Operating Current	mA		300	350
Operation Voltage	V		1.6	1.8
Wavelength shift w Temperature	nm/°C		0.08	
Wavelength shift w Current	nm/mA		0.003	
Side mode suppression ratio	dB	35	50	
Internal Photodiode Responsivity	mA/W	5		
Internal Photodiode Dark Current	nA			500
TEC current (-5/60°C)	A			1
TEC Voltage (-5/60°C)	V			1.5
Internal thermistor (25°C)	kOhm	9.5	10	10.5
Fiber type	PM1550 or equivalent			
Coating diameter	µm		900	
Fiber bend radius	mm	30		
Storage case temperature	°C	-40		70
Case operating temperature	°C	-20		60
Lead soldering temperature	°C	255	260	265
Laser diode reverse voltage	V			15
Pigtail termination	FC/APC connector			
Polarization state (PM version)	Aligned to the slow axis			

*: See our tutorial : [fiber coupled laser diode](#)

Standard form factor & Laser diode pinning (standard 14-pin Butterfly Type-1) :

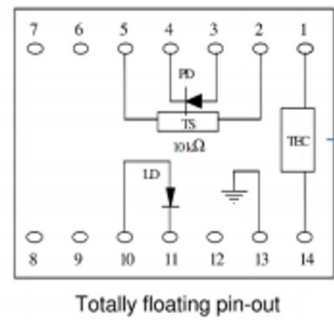
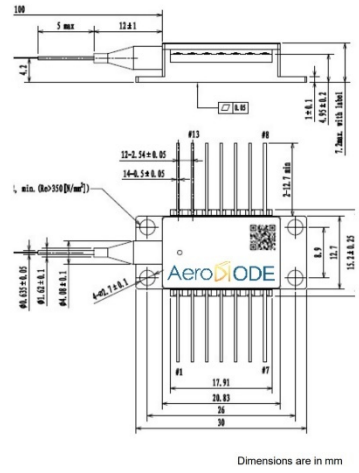

NOTE : Other pin configuration available on demand (Type-2, Type-2 Bias-T etc.)