

*product offered by*



**LASER LAB SOURCE**  
marketplace for **Scientists & Engineers**

[contact@LaserLabSource.com](mailto:contact@LaserLabSource.com)

+1 406.219.1472

[www.LaserLabSource.com](http://www.LaserLabSource.com)

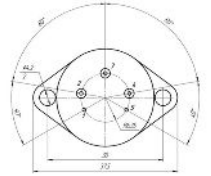

pins 1, 5: Laser Diode Anode  
pin 4: Laser Diode Cathode

## PRODUCT DATA SHEET

Laser Diode (TO-3 package)

Model FB-M1985-300TO3

Specification	Symbol	Typical	Unit
<b>Laser Emitter</b>			
Peak Wavelength	$\lambda_{op}$	1985±15	nm
CW Optical Output Power	$P_{op}$	0.3	W
Operation Current	$I_{op}$	<4.0	A
Operation Voltage	$U_{ld}$	<1.4	V
Threshold Current	$I_{th}$	<1	A
Beam Divergence (FWHM)	$\theta_{  }$	8±2	degree
Beam Divergence (FWHM)	$\theta_{\perp}$	1	degree
Spectrum Half-Width (FWHM)	$\Delta\lambda$	<8	nm
Emitting Area	$W \times d$	100x1	$\mu m \times \mu m$
Operation Mode	CW	continuous	-
Operation Temperature	Top	25	degree
Operation Temperature Range		-20... +40	degree
Storage Temperature Range		-40... +80	degree

Drawings:

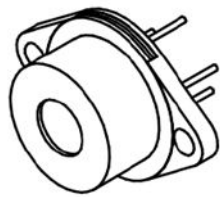
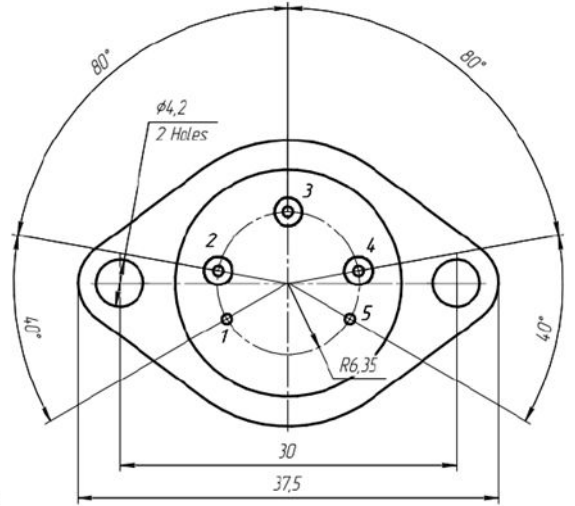
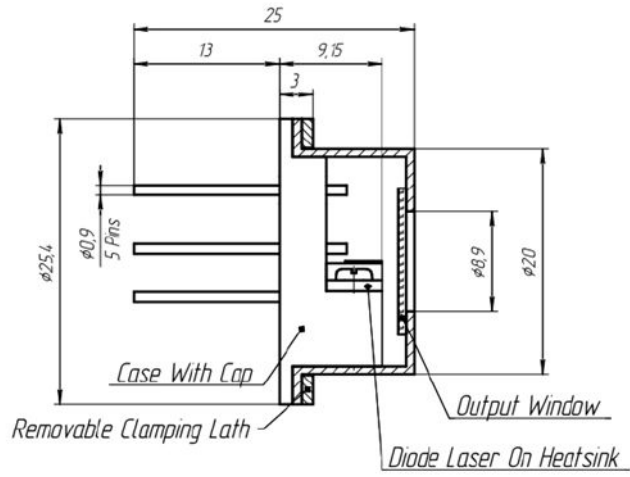

1, 5	LD +
2	
3	
4	LD -

**PRODUCT WARRANTY:**

This product is sold with a full one year warranty. The warranty includes all parts and labor. It is warranted to be free from defects in material and workmanship for a period of one year from the date of shipment. The warranty does not include damage to the product due to customer mishandling or use of the product outside of its specified maximum ratings.

**INSTALLATION SUPPORT OR TECHNICAL SUPPORT FOR THIS PRODUCT:**

**800-887-5065 extension 1**  
**[contact@laserdiodesource.com](mailto:contact@laserdiodesource.com)**



Part of the Laser Lab Source Group:  
[LaserLabSource.com](http://LaserLabSource.com)  
[LaserDiodeSource.com](http://LaserDiodeSource.com)  
[LaserDiodeControl.com](http://LaserDiodeControl.com)  
Laser Diode Technologies

Laser Lab Source Inc.  
1820 W. Lincoln Street  
Bozeman, MT USA 59715  
[contact@LaserDiodeSource.com](mailto:contact@LaserDiodeSource.com)  
[contact@LaserDiodeControl.com](mailto:contact@LaserDiodeControl.com)  
800-887-5065

800-887-5065