

AOM Series Fiber coupled AOM – Free Space AOM & RF Drivers



Contents

Revision Sheet.....	2
1. General information	3
1.1 Definitions.....	3
1.2 General warning.....	3
2. Safety Instructions	4
2.1. AOM Safety instruction.....	4
2.2. RF Driver Safety instruction	4
2.3. Contact.....	5
3. Package Content	5
4. Absolute Maximum Ratings	5
4.1. AOM (Fiber-coupled/Free-space)	5
4.2. RF Driver.....	6
5. Installation	6
5.1. AOM installation	6
5.1.1. Free-space AOM.....	6
5.2. RF Driver installation.....	7
5.3. How to control the RF power level and the RF frequency	9
5.3.1. Frequency measurement :.....	9
5.3.2. Max power measurement :	10
5.3.3. Modulation frequency measurement :.....	11
6. Example of applications	13
6.1. Pulse picking with an AOM	13
6.2. 1 st order diffraction with a free-space AOM.....	14
6.2.1. Typical insertion losses	16
6.2.2. Typical AOM RF tunability.....	16



Revision Sheet

Release No.	Date	Author	Revision Description
V1.0	25/09/2021	SER	First version
V1.1		SER	Second version
V1.2	11/06/2023	SER	Third version – highlight the critical RF power level
V1.3	21/07/2023	SER	Fourth version – highlight the max RF power for the various models
V1.4	22/11/2023	MFA	Fifth version – updated with the free space AOMs
V1.5	28/03/2024	LRB/MFA /AMO	Sixth version – updated with RF power measurement instructions, dual output AOM, applications. Update Warning and Caution.

Disclaimer : Information in this document is subject to change without notice.

Copyright © AeroDIODE

Bât. IOA, rue François Mitterrand

33400 Talence – France www.AeroDIODE.com



1. General information

Please read this manual carefully. It describes the hazard the user might be exposed to while using the product. It also explains in details how to use the product in the safest and most efficient possible way. The safety of any system incorporating the product is the responsibility of the assembler of the system. Any actions taken by the user that is not clearly described in this user manual might present a risk and is the sole responsibility of said user.

This product is to be used in laboratory or industrial tasks, and only by personnel who have followed a training in laser hazard.

This product is an OEM device for system integration. It is designed for use as a component (or replacement) part and is thereby exempt from 21 CFR1040.10 and 1040.11 provisions. **Make sure it is not put in operation before the machine in which it will be integrated has been declared to be compliant with the relevant requirements of the current directives :**

- 2006/25/CE (following for example the regulation NF EN 60825-1) (Europe)
- 21 CFR1040.10 and 1040.11 provisions (USA)

1.1 Definitions

Caution : A “caution” is advised when dealing with hazardous situations, tasks or objects, to avoid material damage or failure.

Warning : A “warning” is given for potentially dangerous situation for people which cause them harm or lead to death

Note : A note is a complementary piece of advice that must be acknowledged by the user.

1.2 General warning

WARNING

The compatible laser sources used with the AOM can deliver up to several Watts of coherent LASER radiation. **Always wear protective goggles** and observe the safety instructions provided by the laser diode supplier when using the AOM and/or AOM driver with your laser source.

Caution

Do not try to open or remove the cover of the AOM or RF driver modules.



Caution

Avoid all shocks and strains when handling the AOM

Caution

Handle the fiber-optic cables with care as it is fragile. Do not bend or pinch it.

WARNING

Any settings or hardware tinkering that is not described in this user manual or in the usage recommendation may put the user or its environment at risk.

WARNING

The maintenance and servicing of the AOM should NOT be executed by the end user : only AeroDIODE is able to maintain the AOM.

2. Safety Instructions

2.1. AOM Safety instruction



WARNING

Not following the safety recommendations and the caution mentioned above can lead to eye damage.

2.2. RF Driver Safety instruction



Caution

Do not power up the signal output interface when it is open or shorted. Risk of permanent damage.

Caution

The product should be well grounded, otherwise the performance can be affected.

Caution

The product is sensitive to ESD.



2.3. Contact

If you have any question about the AOM module, please contact AeroDIODE :
www.aerodiode.com

3. Package Content

The AOM modules comes with:

- 1 AOM module with 900 μm fiber and 2* FC/APC fiber connectors **OR** 1 Free-Space AOM with adapted mounting base **OR** 1 dual output AOM with 900 μm fiber and 3* FC/APC fiber connectors.
- A USB Key with the current user manual in pdf

The Driver part comes with :

- An SMA/SMA cable to connect the RF driver to the AOM
- An SMA/BNC cable to connect the RF driver to an AWG
- A special cable with Banana plugs to connect to a benchtop power supply

4. Absolute Maximum Ratings

4.1. AOM (Fiber-coupled/Free-space)

- Optical power (CW) : refer to the AOM model Datasheet
- Storage temperature -40 to +85°C
- Operating temperature 0 to +60°C
- **Caution** : Applying a maximum RF power (voltage) above the maximum efficiency can lead to AOM permanent damage. As a first test level : a maximum RF power below 2W must be securely set.

CAUTION : The table below show the various typical and absolute max RF powers :

Model (wavelength/RF frequency)	Typical RF power (W)	Absolute Max RF power (W)
780 / 100 MHz	1	2.0
780 / 200 MHz	1,5	2.0
850 / 100 MHz	1.8	2.0
850 / 200 MHz	2.3	2.5
940 or 1064 / 100 MHz	1,8	2.0
940 or 1064 / 200 MHz	2,3	2,5
1310 / 1550 or 1650 / 80 MHz	2,3	2,5
1310 / 1550 or 1650 / 200 MHz	2,3	2,5



4.2. RF Driver

- Operating voltage: +24V DC
- Control signal levels from 0 to +5.5V
- Storage temperature -40 to +85°C
- Operating temperature 0 to +60°C

5. Installation

5.1. AOM installation

1. Wear safety Goggles
2. Wear a proper and working ESD wrist strap;
3. **Caution** : Set the module on a heat dissipating surface (an optical table works fine). Letting the AOM in air with no dissipating surface leads to overheating and permanent damage.
4. The light can be inserted in any direction. The performance are the same (insertion loss, extinction ratio etc.)
5. **Caution** : when using another RF driver, The RF power shall not be set over the maximum diffraction efficiency level. A power over 2W can lead to a permanent damage. The RF power must be adjusted progressively from 0 V up to the maximum diffraction level.

5.1.2. Free-space AOM

For free-space AOM, a specific mounting plate is provided. This plate has to be screwed to the AOM on one side, and to a M4 optical post on the other side. This would help to mount the AOM onto an optical table (see below).

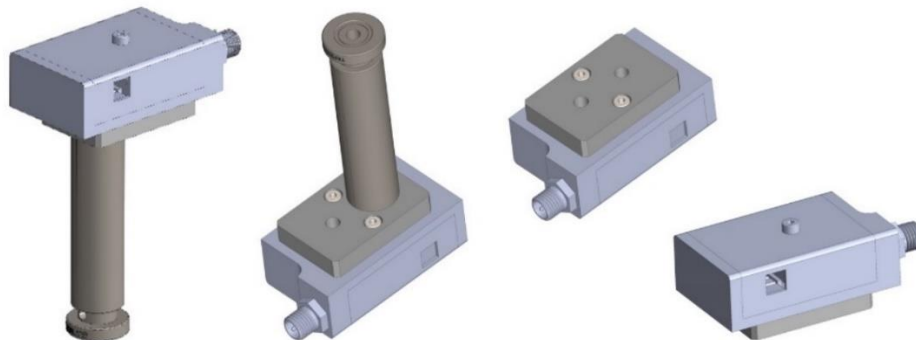

5.2. RF Driver installation

The product is dissipated by conducting heat. The product shall be mounted on a metal structure using fixing screws. The mounting surface shall be flat with minimum size and thickness. A certain amount of space should be reserved around and above the product.

The product is powered by a DC of + 24V, and the power connector is supplied with a per-centric capacitor; The core of the heart capacitor is connected to the positive power supply, and the grounding sheet of the heart capacitor is connected to the negative pole of the power supply. The characteristic impedance of the product signal output port is 50 Ω .

The product receives both external pure analog and/or digital modulation.

The adjustment of RF output power is achieved by changing the resistance of a multi-turner : turn clockwise to increase the output power, turn counterclockwise to decrease the output power.

1. Make sure the RF Driver has the correct RF frequency required by the AOM model (model 1 : 100 MHz, model 2 : 200 MHz, model 3 : 80 MHz ; model 4 : 200 MHz).
2. Make sure the RF Driver model is the one you need (TTL input or Analog input).
3. Connect the RF driver to the AOM with the SMA cable. If you use the modular model RFAOM-TA-200, set the S1-S4 switch to the proper configuration (see below)
Caution : Always connect the RF driver to the AOM before powering, using the RF driver without a charge could lead to a permanent damage.
4. **Caution :** Place the module on a heat dissipating surface (an optical table works fine). Letting the RF driver in air with no dissipating surface leads to overheating and permanent damage.
5. Connect a 24V >0.5A power supply to the RF driver
6. **Caution :** The RF power shall not be set over the maximum diffraction efficiency level. A power over 2W rapidly leads to a permanent damage. The RF drivers power level (little screw) is normally set in a safe area allowing a correct diffraction efficiency. If ever it is adjusted, this must be done progressively from 0 V up to the maximum diffraction level. If necessary, you can monitor the RF power level using a scope and a 20 dB attenuator (because of the strong voltage amplitude), see part 5.3.
7. Connect the trigger signal and make sure you apply the good electric signal :
 - TTL 5V-50 Ohm for standard RF-AOM-T-xxx model,
 - Analog 0-5V signal for RF-AOM-A-xxx
 - Any signal (0-5V or 0.1V) for the modular RFAOM-TA-200 model
8. If you need to optimize the insertion loss, apply a small optical CW signal at the proper wavelength and apply a CW trigger signal to the RF Driver. Use a screwdriver (\varnothing 3mm – Multiturn) to adjust the RF power to get maximum optical power at the output of the AOM.



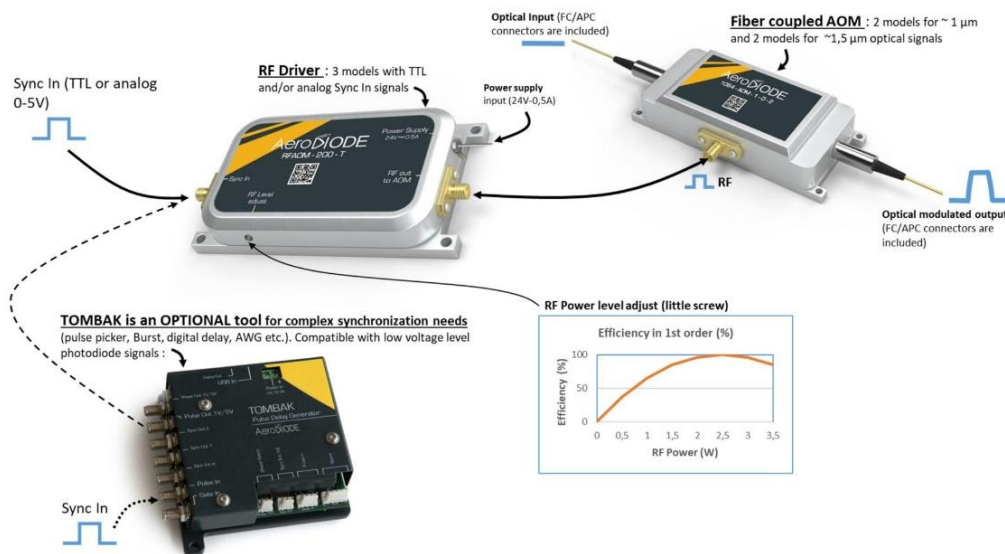

Figure 1 Example of integration of standard model (either RF_AOM-T-xxx or RF_AOM-A-xxx) at either 80, 100 or 200 MHz :



Figure 2 : Model RFAOM-TA-200 S1-S4 settings

RFAOM-TA-200 Configuration switch :

- S1 : Down : TTL high ; Up : TTL low input signal configuration setting
- S2 : Down : TTL mode active ; Up : TTL mode disabled
- S3 : Down : Analog input range : 0 -1V ; Up : Analog input range 0 - 5V.
- S4 : Down : Analog mode active ; Up : Analog mode disabled



5.3. How to control the RF power level and the RF frequency

For this setup, you need :

- An oscilloscope (50 Ohm impedance input, bandwidth tuned to maximum)
- A 20dB attenuator
- A RF driver
- An AWG (or AeroDIODE TOMBAK)
- A 24 VDC power supply
- 2 SMA/SMA or SMA/BNC cables (according to your AWG and scope)

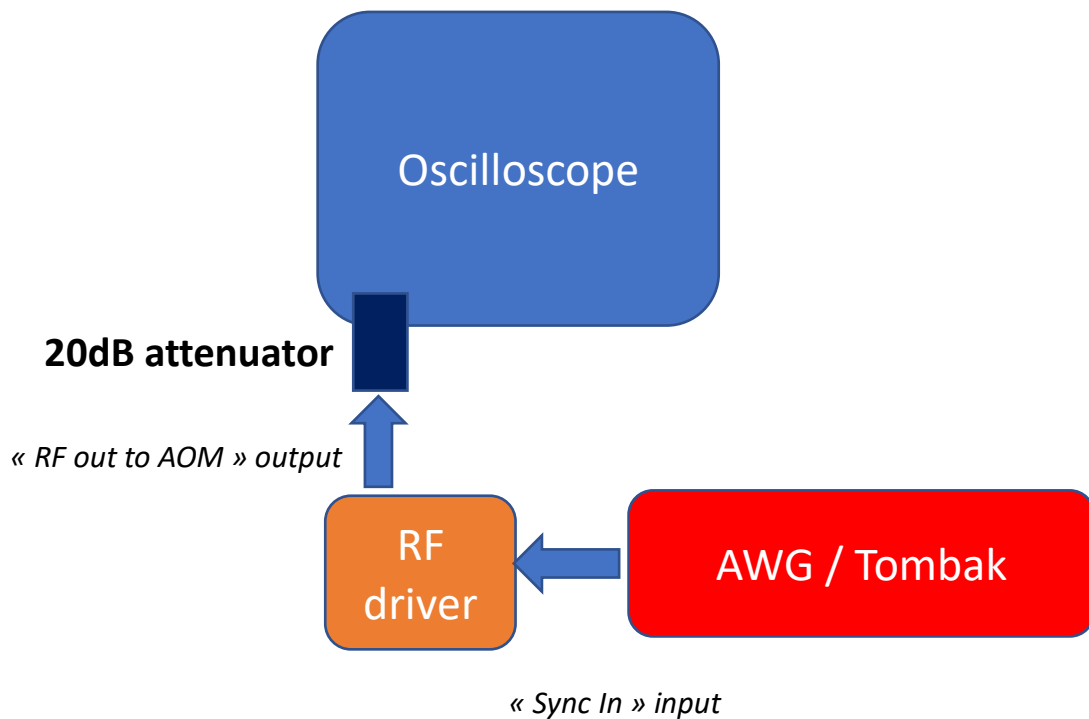

5.3.1. Frequency measurement :

- Adjust your AWG parameter to get a +5V offset (50 Ohm impedance) signal.
- Connect your SMA/SMA cable or SMA/BNC cable between the “RF out to AOM” output from the driver to the 20 dB attenuator which is connected to one of the oscilloscope channels.
- Connect the power supply to your RF driver



- Turn the 24VDC power supply on (only when the RF signal is connected to the oscilloscope through the attenuator!).
- Turn your AWG signal on (only when the 24VDC power supply is turned on!).
- Observe the RF frequency modulation (80 MHz, 100 MHz, 200 MHz or else if custom).

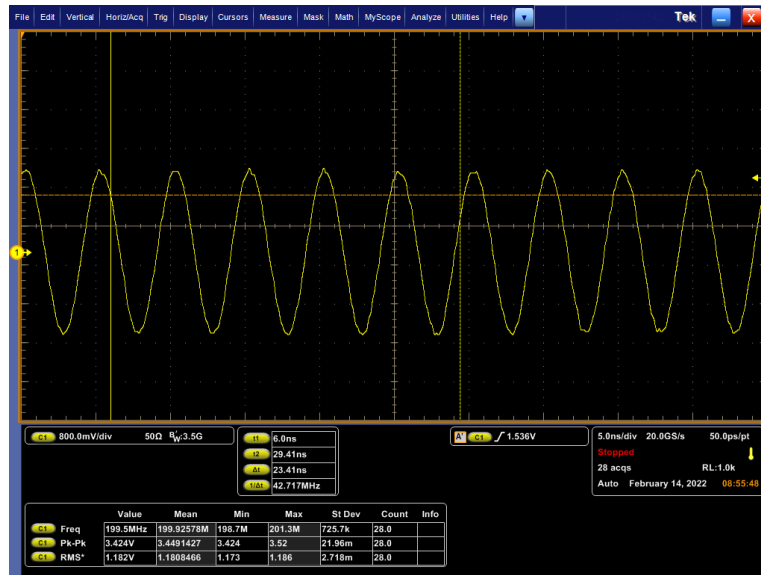

Figure 3 : Monitoring of the RF frequency

5.3.2. Max power measurement :

Keep the same setup. Display the RMS voltage on your oscilloscope.

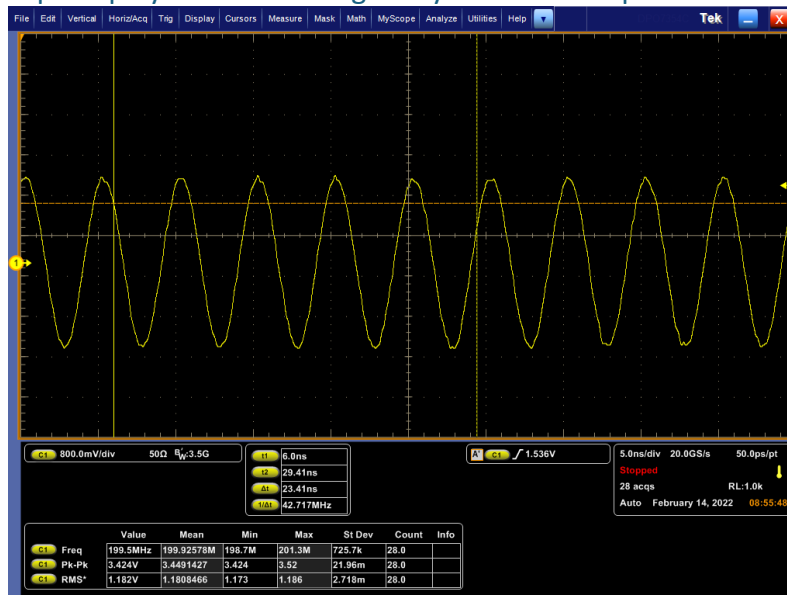

Figure 4 : Monitoring of the RMS voltage of the RF signal

You can calculate the RF power by applying the following formula: $P_{max} = \frac{100 \times V_{RMS}^2}{50}$

For a voltage of 1.19 V_{RMS} , the output power is of 2.8 W.

If the measured power differs from what's indicated in the test report, you can adjust it rotating clockwise or counter-clockwise with a screwdriver (\varnothing 3mm – Multiturn) the screw which is located below the “RF level adjust” label in the RF driver.

5.3.3. Modulation frequency measurement :

- If the RF driver is analogic : send a 0-5 V (50 Ohm impedance) sinus-shaped signal of 10 kHz into the “Sync In” input port from the RF driver.

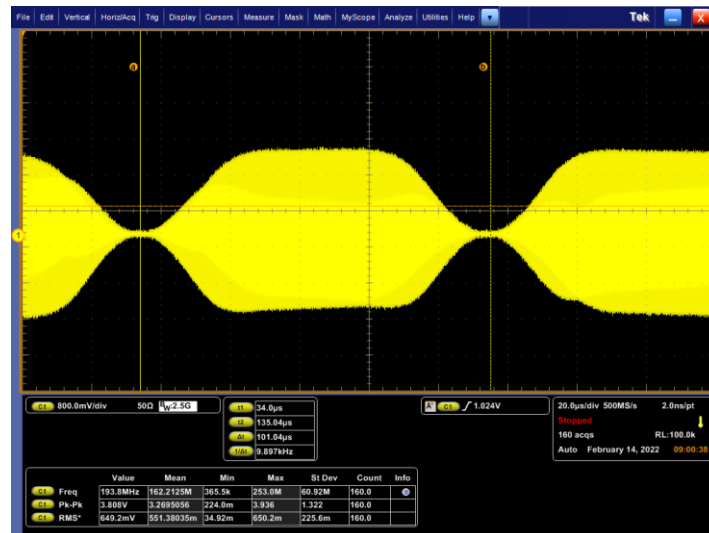

Figure 5 : Monitoring of the modulation triggering analog signal

- **If the RF driver is numeric (TTL)** : send a 0 V-5 V (50 Ohm impedance) square-shaped of 10kHz into the “Sync In” input port from the RF driver.

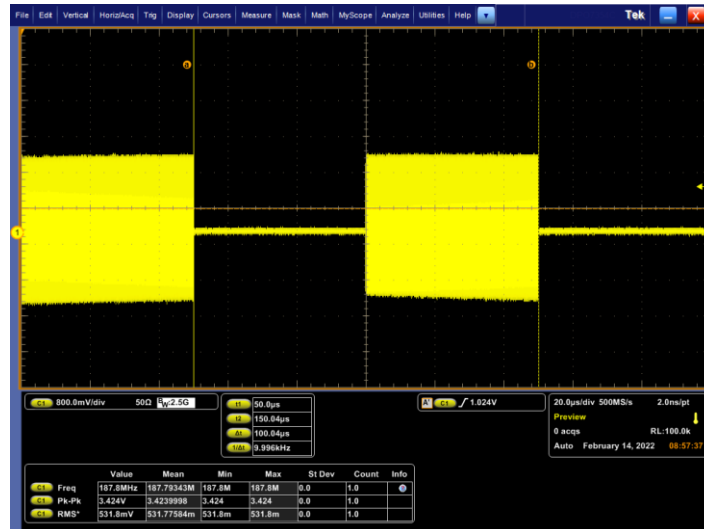

Figure 6 : Monitoring of the modulation triggering TTL signal

- **If the RF driver is both analog and numeric (TTL)** : refer to the switch position (part 5.2) and do both previous measurements.

Comparison of AOM's analog and TTL drivers

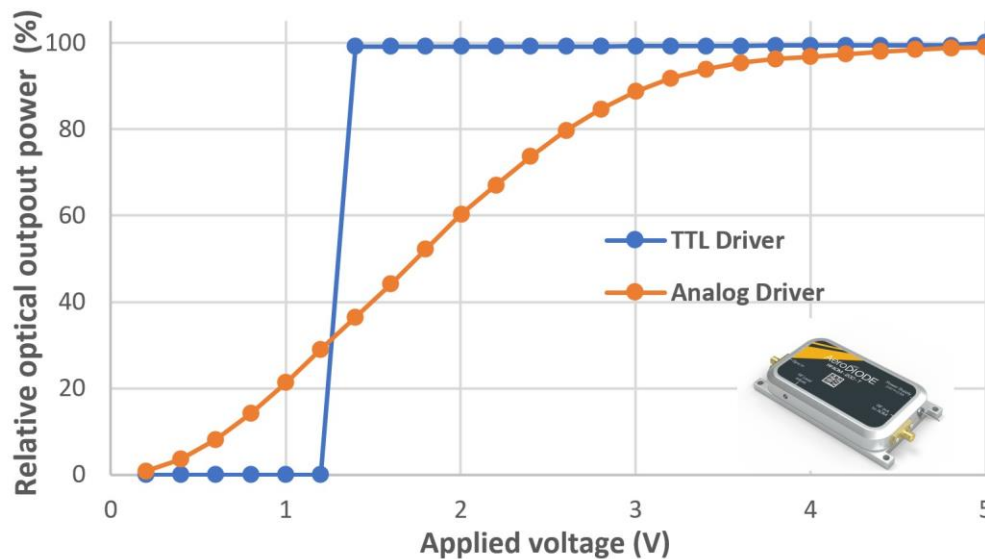

Figure 7 RF output power variation with applied modulation voltage into analog or numeric RF driver

6. Example of applications

6.1. Pulse picking with an AOM

To setup your pulse picker, you need :

- A fiber-coupled or free-space AOM
- A RF driver
- An AeroDIODE TOMBAK pulse-picker synchronization tool
- A laser source (with a triggering frequency output or a photodetector to detect the pulse frequency)
- A photodetector
- SMA/SMA and SMA/BNC cables
- An oscilloscope (if necessary)

The synoptic diagram is as follows:

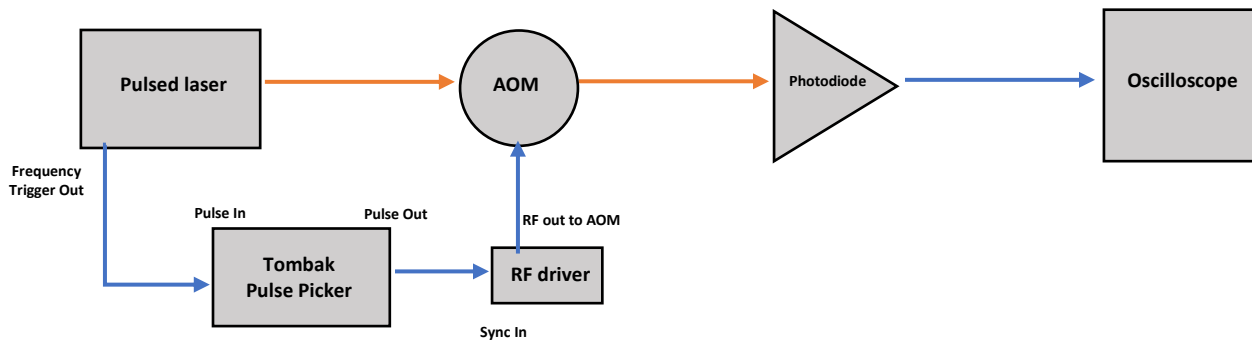

- The Tombak Pulse Picker divides the input triggering frequency and send the generated signal to the “Sync In” RF driver input. (Note that the Tombak Pulse picker synchronization allows to configure several pulse-picking modes, including some modes with external low frequency triggering). See this [product web page](#) for more information.
- Adjust the pulse width and the delay of the generated signal to get a better extinction ratio between each pulse.





Figure 8 Pulse-picking measurement result.

6.2. 1st order diffraction with a free-space AOM

To setup your 1st order diffraction, you need :

- A free-space AOM with mounting adapter
- An optical post or a specific translation or tilted stage.
- A RF driver
- An AWG (or AeroDIODE Tombak)
- A laser source (collimated or with an external collimator)
- A photodetector
- SMA/SMA and SMA/BNC cables
- An oscilloscope or powermeter (if necessary)

The synoptic diagram is as follows :

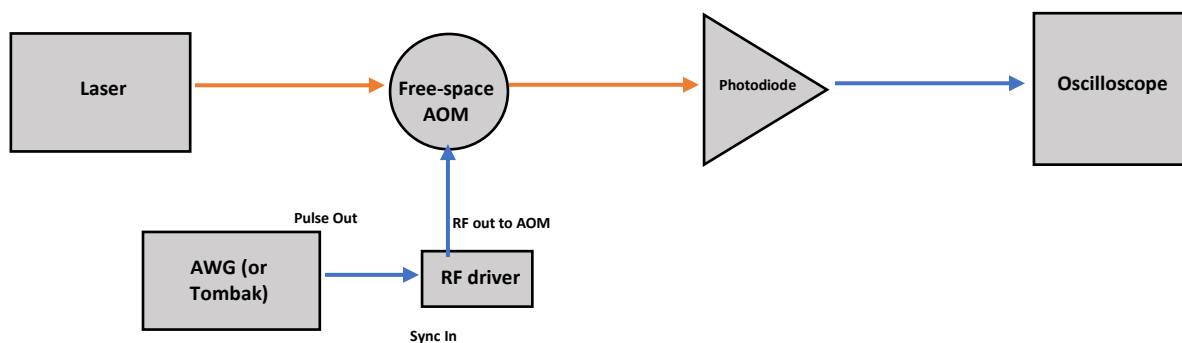

- Make sure the AOM input beam diameter is in the range of the free-space AOM acceptable beam diameter. This will help to get the better diffraction efficiency.
- Move the free-space AOM in order to focus at best the input beam into the AOM slot.
- If your setup is adjusted, you should see the zero order (non-diffracted beam) and the first order (diffracted). If necessary, translate the AOM to get the highest power/signal at the AOM output.

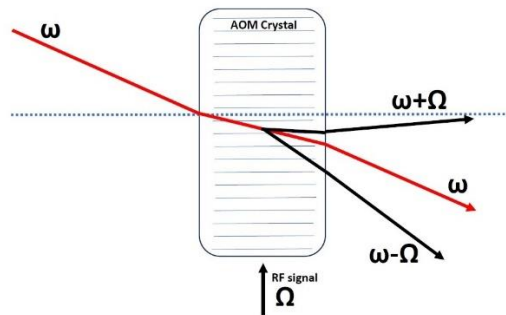

Figure 9 Diffraction principle by the AOM (acousto-optic effect)

Diffraction angle:

The diffraction Angle can be calculated using the following formula :

$$\theta = \lambda * f / V$$

- θ : diffraction angle (in mrad) ;
- λ : wavelength (in nm)
- f : RF frequency (in MHz)
- V = velocity of sound = 4200

Example : 635 nm , 200 MHz RF frequency => $\theta = 30$ mrad

6.2.1. Typical insertion losses

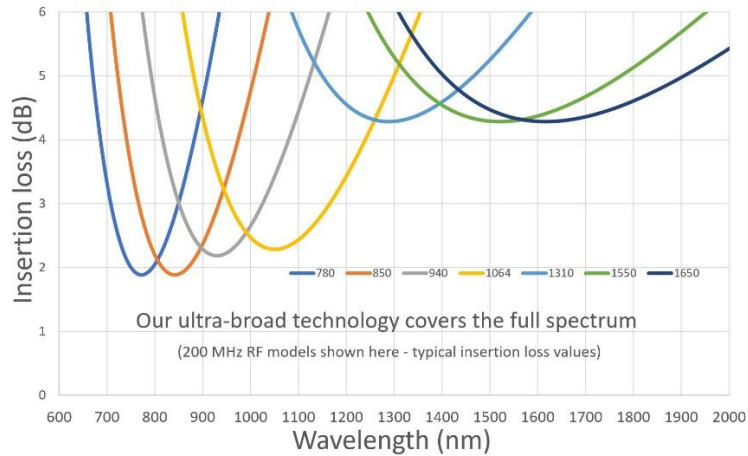

Figure 10 Typical insertion losses as a function of the input wavelength into AOM various models

6.2.2. Typical AOM RF tunability

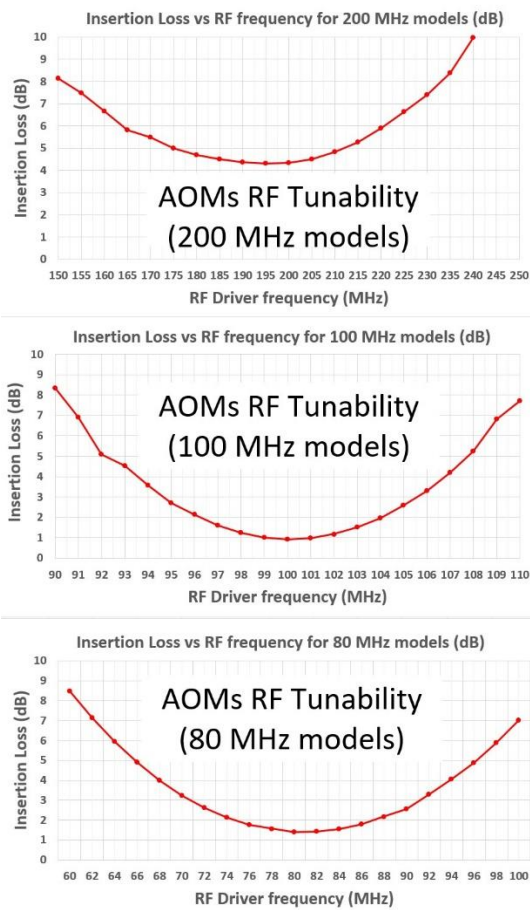

Figure 11 AOM RF tunability for each of the AOM RF frequencies

