

1310 nm SLED

1 mW / singlemode fiber / Butterfly package



Reference: SLED-I1310-1

SPECIFICATIONS	Unit	Min	Typ	Maximum
Output Power	mW	1		
Center Wavelength	nm		1310	
Spectral Width (FWHM)	nm	40		
Spectral Ripple	dB			0.2
Operating Current	mA		75	120
Operating Voltage	V		1.5	
TEC current (25°/case@65°)	A			1.0
TEC voltage (25°/case@65°)	V			2.0
Internal thermistor (25°)	kOhm	9.5	10.0	10.5
Fiber type	SMF28 (eq) or PM1550 (eq.)			
Fiber bend radius	kgf			1
Storage temperature	°C	-40		+85
Operating case temperature	°C	-20		+70
Operating chip temperature	°C	+15		+45
Laser diode reverse voltage	V			2
Soldering temperature/time	°C/S			260/10

Form factor:

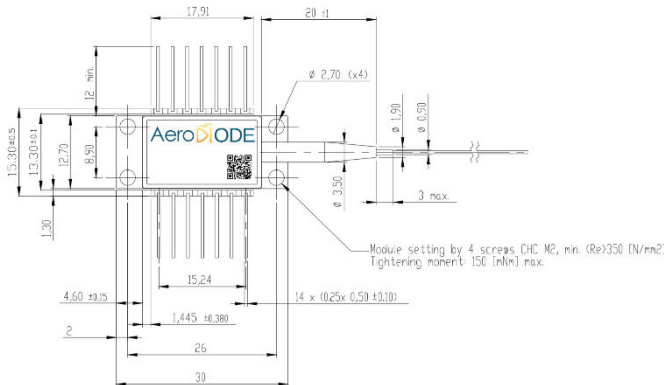

SLED pinning:

